



WALL CONNECTOR, 80A SINGLE PHASE INSTALLATION MANUAL

Approved Markets: North America, Japan, Taiwan

For additional languages, please visit: www.tesla.com/wallconnector



About this Manual.....2

Product Specifications.....	2
Communications Regulations.....	2
Errors or Inaccuracies.....	2
Copyrights and Trademarks.....	2

Safety Information.....3

Important Safety Instructions.....	3
Warnings.....	3
Cautions.....	3
Notes.....	4

Specifications..... 5

Features.....6

Circuit Ratings.....	6
Self-Monitoring and Recovery.....	6
Power Outages.....	6
Load Sharing.....	6

Planning Your Installation..... 7

Minimum Requirements.....	7
Service Wiring.....	7
Single-Phase With Neutral.....	7
Single-Phase Without Neutral.....	7
120V Above Ground.....	8
Ground Connection.....	8
240V Single-Phase.....	8
200V Single-Phase.....	8
208V 3-Phase Wye-Connected.....	9
240V Three-Phase Delta-Connected.....	9
Determine the Circuit Breaker Requirements.....	9
Choose the Best Location for the Wall Connector.....	10
Installation Considerations.....	11

Check the Box Contents.....13

Step-by-Step Installation

Instructions..... 15

Tools and Materials Required.....	15
Overview of Installation Steps.....	15

Install the Low Profile Bracket for Rear or Bottom Entry Wiring.....	16
Install the Top Entry Bracket for Rear or Top Entry Wiring.....	17
Prepare for Installation.....	18
Connect the Wiring.....	19
Set the Operating Current.....	21
Secure the Cover and Power Up.....	22

Troubleshooting.....24

Reset.....	27
Questions?.....	28

Appendix A: Testing for Proper Operation..... 29

Appendix B: Optional Connection for Load Sharing.. 30

Daisy Chaining Multiple Wall Connectors.....	30
Example of the Communication Wiring.....	31
Other Load Sharing Behaviors.....	31



Product Specifications

All specifications and descriptions contained in this document are verified to be accurate at the time of printing. However, because continuous improvement is a goal at Tesla, we reserve the right to make product modifications at any time.

Communications Regulations

This device complies with Part 15 of the FCC rules and Industry Canada license-exempt RSS standard(s). Operation is subject to the following two conditions: (1) This device may not cause harmful interference and (2) this device must accept any interference received, including interference that may cause undesired operation.

⚠ Important: Changes or modifications to this product not authorized by Tesla could void the FCC compliance.

Errors or Inaccuracies

To communicate any inaccuracies or omissions, or to provide general feedback or suggestions regarding the quality of this manual, send an email to:

ownersmanualfeedback@tesla.com

Copyrights and Trademarks

All information in this document is subject to copyright and other intellectual property rights of Tesla, Inc. and its licensors. This material may not be modified, reproduced or copied, in whole or in part, without the prior written permission of Tesla, Inc. and its licensors. Additional information is available upon request. The following are trademarks or registered trademarks of Tesla, Inc. in the United States and other countries:

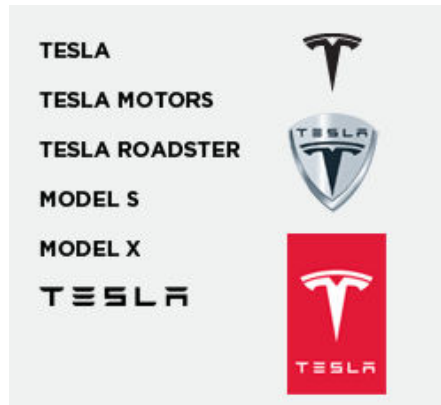











All other trademarks contained in this document are the property of their respective owners and their use herein does not imply sponsorship or endorsement of their products or services. The unauthorized use of any trademark displayed in this document or on the vehicle is strictly prohibited.







Important Safety Instructions



This document contains important instructions and warnings that must be followed when installing and maintaining the Wall Connector.

Warnings

-  **Warning:** Read all the instructions before using this product.
-  **Warning:** This device should be supervised when used around children.
-  **Warning:** The Wall Connector must be grounded through a permanent wiring system or an equipment grounding conductor.
-  **Warning:** Do not install or use the Wall Connector near flammable, explosive, harsh, or combustible materials, chemicals, or vapors.
-  **Warning:** Turn off input power at the circuit breaker before installing or cleaning the Wall Connector.
-  **Warning:** Use the Wall Connector only within the specified operating parameters.
-  **Warning:** Never spray water or any other liquid directly at the wall mounted control box. Never spray any liquid onto the charge handle or submerge the charge handle in liquid. Store the charge handle in the dock to prevent unnecessary exposure to contamination or moisture.
-  **Warning:** Stop using and do not use the Wall Connector if it is defective, appears cracked, frayed, broken, or otherwise damaged, or fails to operate.
-  **Warning:** Do not attempt to disassemble, repair, tamper with, or modify the Wall Connector. The Wall Connector is not user serviceable. Contact Tesla for any repairs or modification.
-  **Warning:** When transporting the Wall Connector, handle with care. Do not subject it to strong force or impact or pull, twist, tangle, drag, or step on the Wall Connector, to prevent damage to it or any components.

-  **Warning:** Do not touch the Wall Connector's end terminals with fingers or sharp metallic objects, such as wire, tools, or needles.
-  **Warning:** Do not forcefully fold or apply pressure to any part of the Wall Connector or damage it with sharp objects.
-  **Warning:** Do not insert foreign objects into any part of the Wall Connector.
-  **Warning:** Use of the Wall Connector may affect or impair the operation of any medical or implantable electronic devices, such as an implantable cardiac pacemaker or an implantable cardioverter defibrillator. Check with your electronic device manufacturer concerning the effects that charging may have on such electronic devices before using the Wall Connector.

Cautions

-  **Caution:** Do not use private power generators as a power source for charging.
-  **Caution:** Incorrect installation and testing of the Wall Connector could potentially damage either the vehicle's Battery and/or the Wall Connector itself. Any resulting damage is excluded from the New Vehicle Limited Warranty and the Charging Equipment Limited Warranty.
-  **Caution:** Do not operate the Wall Connector in temperatures outside its operating range of -22°F to 122°F (-30°C to +50°C).



Notes

Note: Ensure that the Wall Connector's charging cable is positioned so it will not be stepped on, driven over, tripped on, or subjected to damage or stress.

Note: Do not use cleaning solvents to clean any of the Wall Connector's components. The outside of the Wall Connector, the charging cable, and the connector end of the charging cable should be periodically wiped with a clean, dry cloth to remove accumulation of dirt and dust.

Note: Be careful not to damage the circuit boards or components during installation.

Note: Use a cable sheath or similar containment to cover the supply cables. The color black is recommended.



The maximum power rating for the Wall Connector is 20 kW or 80A at 250V AC single-phase power.

Description	Specifications
Voltage and Wiring	208V or 240V AC single-phase: L1, L2, and earth
Current	Maximum output: 80A, 72A, 64A, 56A, 48A, 40A, 36A, 32A, 28A, 24A, 20A, 16A, 12A
Frequency	50 to 60 Hz
Cable Length	8.5' (2.6 m) and 24' (7.4 m)
Wall Connector Dimensions	Height: 15.0" (380 mm) Width: 6.3" (160 mm) Depth: 5.5" (140 mm)
Top Entry Bracket Dimensions	Height: 10.8" (275 mm) Width: 5.1" (130 mm) Depth: 2.0" (50 mm)
Weight (including bracket)	20 lb (9 kg)
Operating Temperature	-22°F to 122°F (-30°C to 50°C)
Storage Temperature	-40°F to 185°F (-40°C to 85°C)
Enclosure Rating	Type 3R
Agency Approvals	cULus listed for United States and Canada under file number E354307, FCC Part 15.
Ventilation	Not Required



Circuit Ratings

Use a single-phase circuit breaker rated for 100A single phase to obtain the fastest charging.

In certain installation locations, this level of power isn't readily available. Therefore, you can adjust the circuit breaker rating on the Wall Connector from 15A to 100A (refer to Set the Operating Current on page 21).

Note: Actual amperage draw will depend on the on-board charger of the vehicle. Contact Tesla if you have questions about the on-board charger of a specific vehicle.

Self-Monitoring and Recovery

The Wall Connector has a ground monitoring circuit that continuously checks for the presence of a safe ground connection and automatically recovers from faults. Manual testing and resetting is not required.

Temporary problems such as ground faults or utility power surges are overcome automatically. If a residual current fault occurs that interrupts charging, the Wall Connector automatically tries to clear the fault and re-attempt charging.

If the problem is immediately sensed a second time, the Wall Connector waits 15 minutes before trying to charge. This process repeats 4 times and if all attempts are unsuccessful, power is removed and no further attempts are made. In this case, you will see a red error light on the front panel (refer to Troubleshooting on page 24). It is recommended that when you see a red error light, you power off the Wall Connector by switching off the upstream circuit breaker, and then power it back on again.

The Wall Connector can alternatively be reset when a red error light is encountered using the RESET button (refer to Reset on page 27).

Power Outages

If a power outage occurs, the Wall Connector automatically resumes charging when power is restored. If the charging cable is plugged into the vehicle when power is restored, the lights blink and the unit does not energize the charging cable for approximately 15 seconds to three minutes. This prevents the utility grid from experiencing a large surge when power is restored and allows vehicles to begin drawing current at random times, rather than all at once.

Load Sharing

The Wall Connector provides the capability to wire 4 Wall Connectors to a single circuit with automatic load management, giving vehicle owners reassurance that they can charge multiple vehicles at home (refer to Appendix B: Optional Connection for Load Sharing on page 30).



Minimum Requirements

Installation of the Wall Connector requires that you:

- Calculate the existing electrical load to determine the maximum operating current.
- Calculate the distance to ensure minimal voltage drop.
- Obtain any necessary permits from the local authority that has jurisdiction and confirm that the follow-up inspection has been scheduled by an electrician after the installation is complete.
- Use only copper conductors.
- Use conductors that are sized in accordance with local wiring regulations. The selected cable must be able to sustain periods of constant load of up to the maximum amperage selected by the electrician.
- Use protective devices. The circuit protection device chosen must incorporate overcurrent protection in relation to the electrical load selected.

Note: Consult with an electrician to ensure that the installation meets local regulations.

Service Wiring

- Warning:** The Wall Connector is a single-phase device. Do not connect all three phases of a three-phase feed.
- Warning:** Before installing the Wall Connector, identify the type of utility service connection available on site.
- Caution:** If a 240V three-phase feed is from a Delta-connected secondary, the leg used must have a center tap. This center tap must be grounded. Only the two phases on either side of the centertapped leg can be used.

Only three wires are connected, but care must be taken that the service transformer secondary connection is definitely known, and that the three wires from the main circuit breaker panel are correctly connected and labeled.

- Caution:** The two phases used must each measure 120V to neutral. Earth ground should be connected to neutral at only one point, usually at the breaker panel.

Single-Phase With Neutral

For single-phase use of a Wye-connected secondary, only a single-phase (L1) and neutral should be connected. The phase to neutral voltage measurement are shown in the illustration below.

- Warning:** The Wall Connector in this configuration operates only from a single-phase (L1). Do not connect the remaining phases (L2 and L3).
- Warning:** Before installing the Wall Connector, identify the type of utility service connection available on site. If you are unsure about the type of connection available at the service panel, consult an electrician, or contact Tesla for assistance.

Note: Consult with your local electrician or refer to your local code for proper wire sizing appropriate for the currents in your Wall Connector.

Single-Phase Without Neutral

For installations without a neutral and 220-240V from phase to phase, connect any two phases (L1, L2, or L3 in the illustration) to the L1 and N positions on the Wall Connector terminal block.

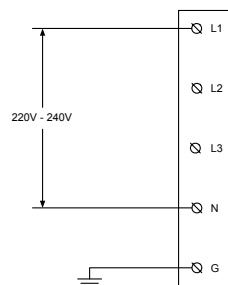



120V Above Ground

- Warning:** The Wall Connector is a single-phase device. Do not connect all three phases of a three-phase feed.
- Warning:** Before installing the Wall Connector, identify the type of utility service connection available on site. If you are unsure about the type of connection available at the service panel, consult an electrician, or contact Tesla for assistance.
- Caution:** The two phases used must each measure 120V to neutral. Earth ground must be connected to neutral at only one point, usually at the breaker panel.
- Caution:** If a 240V three-phase feed is from a Delta-connected secondary, the leg used must have a center tap. This center tap must be grounded. Only the two phases on either side of the center-tapped leg can be used.

Only three wires are connected, but care must be taken that the service transformer secondary connection is definitely known, and that the three wires from the main circuit breaker panel are correctly connected and labeled.

Note: The L1, L2, and ground outputs labeled on the illustrations correspond to the inputs on the Wall Connector.

Ground Connection

Always connect the Neutral at the service to Earth Ground. Ground fault protection is not possible unless the Neutral (center tap on the service transformer) is connected to an Earth Ground. If ground is not provided by the electrical service, you must install a grounding stake nearby. The grounding stake must be connected to the ground bar in the main breaker panel, and Neutral connected to Ground at that point.

240V Single-Phase

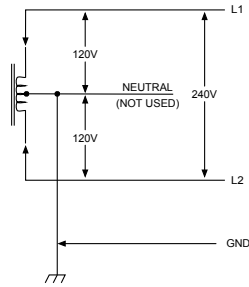

Note: Illustrations in this document are for demonstration purposes only.

200V Single-Phase

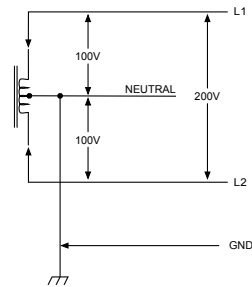

Note: Illustrations in this document are for demonstration purposes only.



208V 3-Phase Wye-Connected

With a Wye-connected secondary, any two of the legs can be used to provide 208V to the Wall Connector. For example, L1 and L2, or L1 and L3, or L2 and L3. The two used phases must each measure 120V to neutral.

Note: A current-carrying neutral is not required.

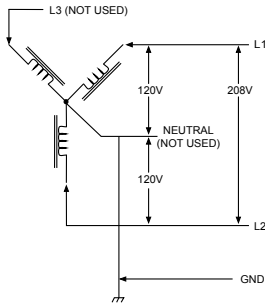

- ⚠ Caution:** The unused leg (L3 in the illustration) must remain open. Do not connect to a neutral bar, or to earth ground.
- ⚠ Caution:** The center point of the three phases (normally used as neutral) must be grounded to earth at only one point. This is usually at the breaker panel.

240V Three-Phase Delta-Connected

With the delta connection, one leg must be center tapped, and only the two phases on either side of the center tap can be used. The two used phases must each measure 120V to neutral.

Consult the transformer manufacturer's literature to verify that the single leg can supply the required power.

Note: The Wall Connector's contactor closes only if it detects the presence of an earth ground wire connected to a neutral point on the transformer secondary.

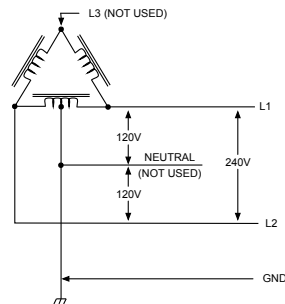

- ⚠ Caution:** The third line (L3 in the illustration) of the delta is 208V, with respect to neutral, and is sometimes referred to as a "stinger." Do not use this third line.
- ⚠ Caution:** Do not use a three-phase delta-connected transformer secondary without a center tap on one leg. No neutral point is available for the required earth ground connection.

Determine the Circuit Breaker Requirements

To determine the type of upstream circuit breaker you need, examine the distribution panel or circuit breaker box to identify the amperage available at the installation site.



The Wall Connector has an internal rotary switch that allows you to adjust its operating current (refer to Set the Operating Current on page 21). The circuit breaker should be rated for the continuous current of: 12, 16, 20, 24, 28, 32, 36, 40, 48, 56, 64, 72, or 80A.

Note: Refer to the circuit breaker current ratings specified on IEC 60898 when installing the Wall Connector. If in doubt, check with your local building electrical inspector.

Choose the Best Location for the Wall Connector

Determine the parking location of the vehicle to ensure that the charge cable reaches the charge port. The Wall Connector should be located:

- In an enclosed garage, typically on the vehicle's charge port side.
- In a well-ventilated area. Avoid installation in an enclosed box, or adjacent to hot appliances.
- 4 ft (1.2 m) above the floor.
- 8 in (190 mm) from any obstructions to allow for cable looping.

Note: The Wall Connector is approved for outdoor use, but it is not designed for complete immersion in liquid. Protection from rain is recommended but not required.



Installation Considerations

Three methods are available to install the Wall Connector. The location of the conduit determines which installation method to follow. If the conduit runs along the floor or low on the wall, use the bottom entry configuration. If the conduit comes from inside the wall, use the rear entry configuration. If the available conduit comes from the ceiling, use the top entry installation.

Note: Throughout the manual, “conduit” is used as the standard term for the protective tubing that houses the service wiring. In regions where conduit is not used (Europe for example), a cable comprised of service wiring enclosed in a protective jacket may be substituted for conduit if allowed by local regulations.

Here are some additional guidelines:

- Conduit openings are sized for 1" (25 mm) conduit.
- Conduit needs to meet all local regulations.
- Use an appropriate circuit breaker.
- To keep the housing weatherproof, use cable glands.
- Use a UL approved conduit connector to ensure proper seal.

Bottom or Rear Entry

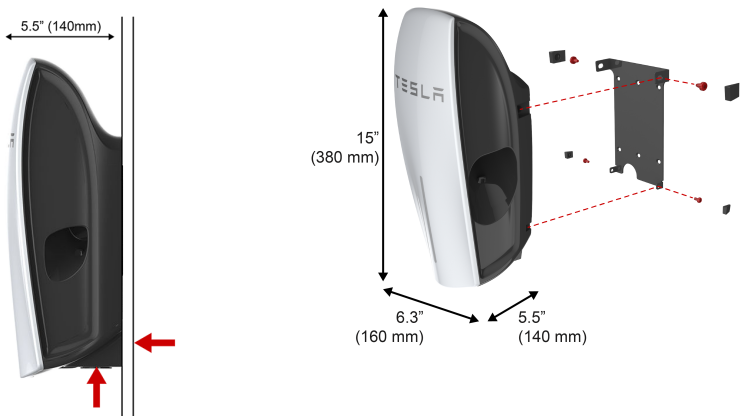



Top Entry

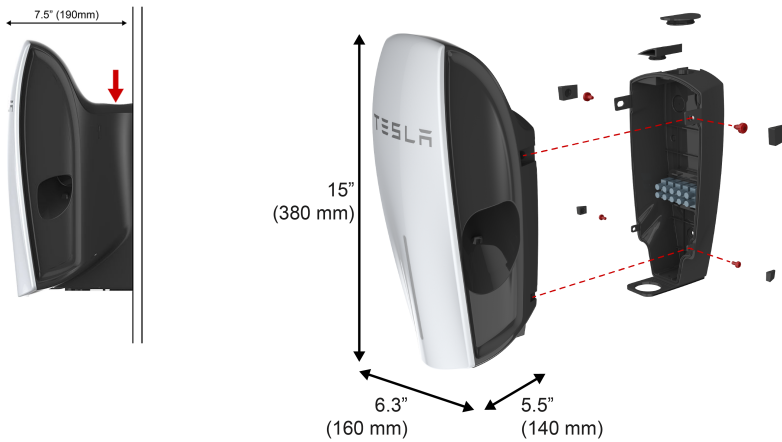



The shipping box contains parts for all installation methods, as well as this manual. If any parts are damaged or missing, contact Tesla (refer to Questions? on page 28).

Note: Not shown is the supplied cardboard template.

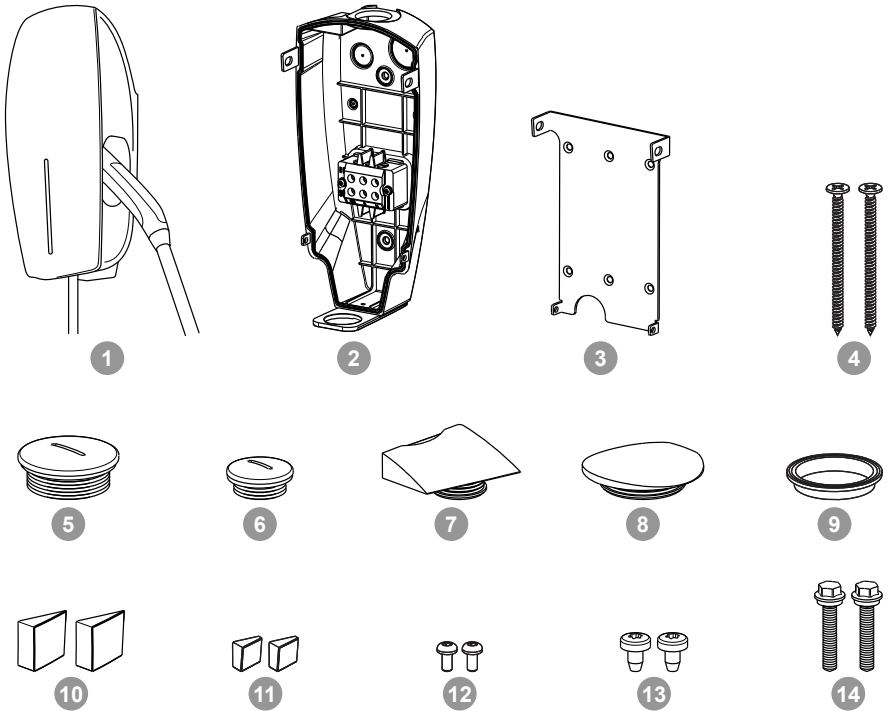

Item	Description (Quantity)
1	Wall Connector
2	Top entry bracket*
3	Low profile bracket **
4	Low profile bracket screws (2) **
5	Bottom or rear entry power conduit plug
6	Bottom or rear entry signal conduit plug
7	Top entry signal conduit plug*
8	Top entry power conduit plug*
9	Bottom conduit sealing gasket*
10	Top bracket-to-housing screw covers (2)
11	Bottom bracket-to-housing screw covers (2)



Check the Box Contents

Item	Description (Quantity)
12	Bottom bracket-to-housing screws (2)
13	Top bracket-to-housing screws (2)
14	Top entry bracket mounting screws (2)*
* Items used in only top entry installations.	
** Items used in only bottom or rear entry installations.	



Tools and Materials Required

Before installing the Wall Connector, gather the following tools and materials:

- Pencil or marker
- Hole punch (optional, to push through cardboard template)
- Wire stripper
- Voltmeter or digital multimeter (to measure AC voltage at the installation site)
- Phillips screwdriver
- Small flathead screwdriver
- Large flathead screwdriver (optional, to remove plastic knock-outs)
- T20 security pin Torx driver
- T10 Torx driver
- M20 and M32 cable glands (also known as sealing hubs)
- Ferrules (the diameter of the ferrule depends on the diameter of the power wiring and the construction)
- Wiring (use twisted pair communication cable 18AWG (Max diameter: 0.04 in (1.02 mm); Max cross-sectional area: 0.03 in² (0.82 mm²) for a maximum of 49 ft (15 m) between Wall Connectors)
- Level
- Machine drill
- Torque driver (for terminal block connections)

Overview of Installation Steps

⚠ Warning: After you run service wiring to the installation site using metal flame retardant conduit, install the appropriate upstream circuit breaker, **TURN OFF AND VERIFY POWER IS OFF BEFORE CONTINUING.**

Then follow these steps to install the Wall Connector:

- Install the Low Profile Bracket for Rear or Bottom Entry Wiring on page 16
- Install the Top Entry Bracket for Rear or Top Entry Wiring on page 17
- Prepare for Installation on page 18
- Connect the Wiring on page 19
- Set the Operating Current on page 21
- Secure the Cover and Power Up on page 22



Install the Low Profile Bracket for Rear or Bottom Entry Wiring

Use the low profile bracket, shown below, to wire the Wall Connector from the rear or bottom.



1. Use the low profile bracket as a guide to mark the location on the wall for the mounting screws.

- Use a level to ensure that the marks are perfectly vertical.
- Space the holes 4.5" (114 mm) apart.

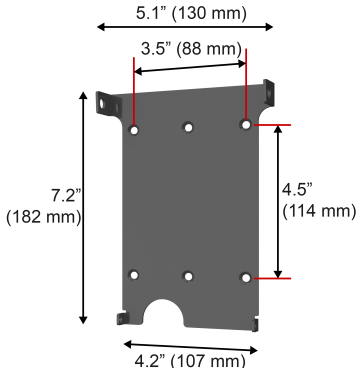

- For U.S.A. installations, position the bracket so that the Wall Connector is located at a maximum of 60" (150 cm) from floor level. The minimum height is 18" (45 cm) if mounting indoors,

and 48" (122 cm) if mounting outdoors.

- If using the rear entry conduit, use at least one set of the edge mounting holes so that the conduit does not interfere with the wall stud.
- If using the bottom entry conduit, use the two center mounting holes.

Note: Ensure that the minimum and maximum height of the bracket is carefully selected. It should be installed out of the way of any reasonably foreseeable impacts.

2. Attach the bracket using fasteners that are appropriate for the type of wall material, drilling pilot holes if necessary. Use the supplied screws only if mounting the bracket directly to a wooden stud. If mounting to another type of wall (hollow, masonry, etc.), use fasteners that are long enough to securely anchor the Wall Connector and can hold at least 80 lb (36 kg).

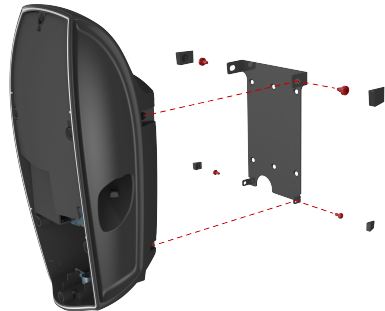



Install the Top Entry Bracket for Rear or Top Entry Wiring

The top entry bracket enables you to route the service wiring into the Wall Connector enclosure from the top of the enclosure, as shown below.



- Use the cardboard template and a level as a guide to mark the location on the wall for the mounting screws.
 - Use a level to ensure that the marks are perfectly vertical.
 - Space the holes 6.1" (155 mm) apart.
 - Position the bracket so that the Wall Connector is located at a maximum of 60" (150 cm) from floor level. The minimum height is 18" (45 cm) if mounting indoors, and 48" (122 cm) if mounting outdoors.
- Note:** Ensure that the minimum and maximum height of the bracket is carefully selected. It should be installed out of the way of any reasonably foreseeable impacts.
- (Optional) There are two additional mounting holes. To use these holes, use a flat-head screwdriver to knock-out the plastic that is closing the holes. These holes are spaced 2.75" (70 mm) apart.

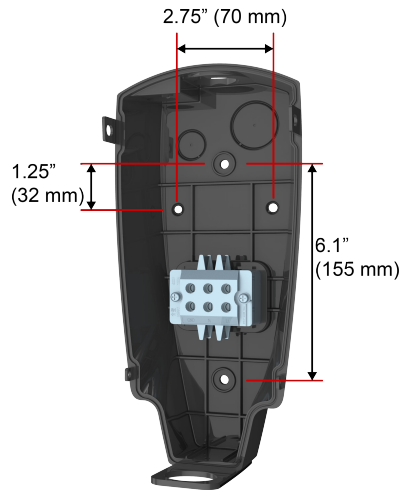

- Attach the bracket using fasteners that are appropriate for the type of wall material, drilling pilot holes if necessary. Use the supplied screws only if mounting the bracket directly to a wooden stud. If mounting to another type of wall (hollow, masonry, etc.), use fasteners that are long enough to securely anchor the Wall Connector and can hold at least 80 lb (36 kg).





Prepare for Installation

Follow these instructions to remove the cover and route the service wiring into the Wall Connector.

1. Use a T10 Torx driver to remove the screw at the bottom of the outer cover. Carefully disengage the snaps on the sides and top using a flathead screwdriver and completely remove the cover. Save the screw and cover for reassembly.



2. Use a T20 security pin Torx driver to remove the six screws on the sealing cover. Carefully remove the sealing cover and disconnect the ribbon cable. Save the screws and cover for reassembly.

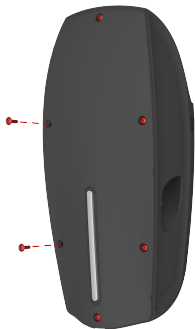

⚠ Caution: Do not allow the sealing cover to hang from the ribbon cable. Doing so can damage the ribbon cable or its connectors.

3. For top entry configuration, install the wiring to the terminal block in the top entry bracket as shown in Connect the Wiring on page 19, then return to this section and proceed to the next step. For back or bottom entry configurations, skip to the next step.
4. Place and hold the Wall Connector on the bracket, ensuring that all four mounting tabs are properly aligned.
5. Use a T20 Torx driver to install the two top housing mounting screws. Push the cosmetic screw covers into place.
6. Use a T20 Torx driver to install the two bottom housing mounting screws. Push the cosmetic screw covers into place.



Connect the Wiring

Note: Consult with your local electrician or refer to your local code for proper wire sizing appropriate for the currents in your Wall Connector.

Note: It is the installer's responsibility to identify whether additional grounding is required to ensure that local regulations are met. Grounding must be installed at the power source and not at the cable entry to the Wall Connector.

⚠ Warning: Do not connect service wiring until you have read and fully understand the concepts described in this section. If you are uncertain about the type of power available at the service panel, consult an electrician, or contact Tesla for assistance.

1. Turn off the power.

⚠ Warning: RISK OF ELECTRIC SHOCK! Before continuing, use a voltmeter to ensure the power is off by confirming that NO VOLTAGE is present at the service wiring or terminals.

2. For top entry installation, pull the service wiring into the top entry bracket or the Wall Connector. Use a 1" (25 mm) cable gland to seal the power conduit or cable. For 80A operation, use 3AWG 167°F (75°C) rated copper wire or follow local regulations.

Note: The meaning of wiring colors might vary from country to country. Follow all applicable national and local regulations concerning wiring color codes.

The following illustration shows an example of the wiring for the top entry bracket.

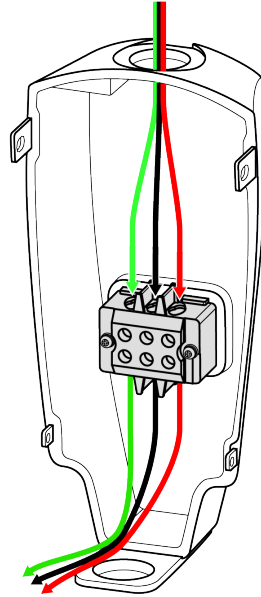

The following illustration shows an example of the wiring for the low profile bracket.

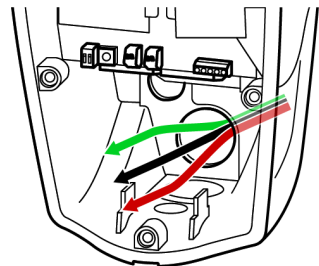

3. Strip the service wires going to the terminal block on the top entry bracket 3/4" (18 mm). Ferrules are recommended.

Note: For top entry installation, the flexible pre-installed wires that go from the top entry bracket to the housing are already terminated and do not need to be stripped.



4. Lead the preconnected service wires in the main housing and connect the preconnected service wires to the main terminal block with L1 (or line), L2 (or neutral), and ground wires going to the locations shown in the following illustration.

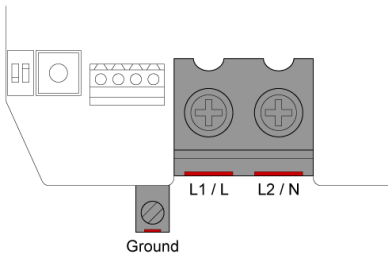

Caution: Cut each of the wire strands and insert them fully into each the terminal block.

Note: To ensure proper operation, verify that neutral is connected to the neutral line inside the circuit breaker box or the main electrical panel.

5. Tighten the terminal block to the recommended torque:
 - 35 in-lb (4.0 N-m) for the terminal block on the top entry bracket.
 - 33 in-lb (3.8 N-m) for the terminal block in the main housing.
 - 18 in-lb (2.0 N-m) for the ground terminal block in the main housing.
6. Check for miswiring using a multimeter and verify that there are no shorts before turning the upstream circuit breaker ON.



Set the Operating Current

Follow these instructions to configure the DIP switch. The following illustration shows an enlarged view of the DIP and rotary switches.

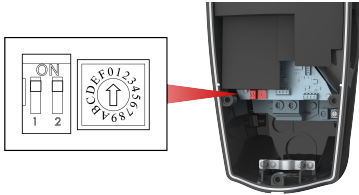

- ⚠ Warning:** Power **MUST** remain OFF before setting or changing the DIP or rotary switches. Changing these switches with the power ON will not be recognized by the system and is dangerous due to the risk of electric shock.

1. Turn OFF power.
2. Use a non-conductive object to adjust the DIP switch settings:

- Switch Position 1:
 - For a Line to Line connection (240V or less) set the DIP switch DOWN.
 - For a Line to Neutral connection (greater than 240V) set the DIP switch to UP (the ON position).

- ⚠ Warning:** Before you set the DIP switches, confirm which type of input service the utility provides.

- Switch Position 2:
 - DIP Switch Position 2 should always be set to UP.

Wiring/Connection	DIP Switch Position
Line to Neutral (greater than 250V)	
Line to Line (240V or less)	

3. Set the rotary switch for the appropriate current setting supported by your circuit breaker. Typical circuit breaker ratings are: 15A, 20A, 25A, 30A, 35A, 40A, 45A, 50A, 60A, 70A, 80A, 90A, and 100A.

Use a small flathead screwdriver to adjust the rotary switch to the appropriate circuit breaker capability setting. The corresponding rotary switch settings for the typical circuit breakers are shown in the following table:



Rotary Switch Position	Maximum Output Current	Circuit Breaker
0	Test mode	N/A
1	12A	15A
2	16A	20A
3	20A	25A
4	24A	30A
5	28A	35A
6	32A	40A
7	36A	45A
8	40A	50A
9	48A	60A
A	56A	70A
B	64A	80A
C	72A	90A
D	80A	100A
E	Not a valid selection	N/A
F	Follower mode	N/A

4. Reattach the ribbon cable to the sealing cover.
5. Reinstall the sealing cover. Use a T20 security pin Torx driver to lightly secure the sealing cover by installing only the top screw.
6. Turn ON power.
7. If the installation is successful, the LEDs briefly sequentially illuminate green with a pattern that ends with the top green LED staying solid ON. If there is a solid or flashing red LED, refer to Troubleshooting on page 24 and resolve the error before you continue.
Note: To review the pattern of blinking lights, press and hold the RESET button for 5 seconds.
8. Turn OFF power.
9. Write the contact information of the installer on the label on the inside of the Wall Connector.

Secure the Cover and Power Up

1. Use a T20 security pin Torx driver to install the remaining screws on the sealing cover. Ensure that the cover is properly aligned before tightening the screws to 8.8 in-lb (1.0 N-m).
2. Attach the outer cover to the sealing cover starting with the latch at the top. Engage the snaps on the sides and align the mounting tab with the housing at the bottom.



3. Use a T10 Torx driver to install the screw that secures the bottom of the outer cover to the housing. Tighten the screw to 4.4 in-lb (0.5 N-m).
4. Close any unused openings with power and signal conduit plugs.
Note: There should not be any visible openings to the inside of the Wall Connector, and the Wall Connector should be completely sealed from the environment.
5. Turn ON the power. The installation is correct if the LEDs go through a sequence of flashing, ending with the top Green LEDs staying solidly ON. If there is a solid or flashing Red LED, resolve the error before you continue (refer to Troubleshooting on page 24).
Note: To review the pattern of blinking lights, press and hold the Reset button for 5 seconds.
6. Attempt to charge the vehicle to ensure the Wall Connector is operating correctly and charging at the selected operating current. For instructions on how to charge,



refer to the owner information provided with the vehicle.



Green Lights	Yellow Light	Red Light	Auto-Retry	What it Means	What to Do
Top light on	Off	Off	Not applicable	Power on. The Wall Connector is powered and in standby but not charging the vehicle.	Not applicable.
Streaming lights	Off	Off	Not applicable	The Wall Connector is charging the vehicle.	Not applicable.
Streaming lights	1 flash	Off	Not applicable	Charging current is reduced due to high temperature detected in the Vehicle Connector.	Make sure the connector is fully inserted into the charge inlet in the vehicle's charging port, is not covered by anything, and there is no heat source is nearby. If the problem persists in normal ambient temperatures (under 100°F or 38°C), contact Tesla.
Streaming lights	2 flashes	Off	Not applicable	Charging current is reduced due to high temperature detected in the wall plug or on the input terminals to the Wall Connector.	If the Wall Connector is hard-wired, make sure it is not covered by anything, and there is no heat source nearby. If the problem persists in normal ambient temperatures (under 100°F or 38°C), contact Tesla.
Streaming lights	3 flashes	Off	Not applicable	Charging current is reduced due to high temperature detected inside the Wall Connector.	Make sure the Wall Connector is not covered by anything and there is no heat source nearby. If the problem persists in normal ambient temperatures (under 100°F or 38°C), contact Tesla.



Green Lights	Yellow Light	Red Light	Auto-Retry	What it Means	What to Do
Off	Off	1 flash	After 15 minutes and up to 4 times	Ground fault. Current is leaking through an unsafe path. Possible Line to ground or Neutral to ground fault.	Try again by disconnecting the Wall Connector from the vehicle and reconnecting. If the problem persists, turn OFF the circuit breaker servicing the Wall Connector, wait 10 seconds, turn the circuit breaker ON again, then try reconnecting the Wall Connector to the vehicle. If the problem persists, contact Tesla.
Off	Off	2 flashes	After 1 minute and up to 4 times	No ground connection detected in the Wall Connector.	Make sure the Wall Connector is properly grounded. If uncertain, consult your electrician to ensure proper grounding at your circuit breaker or power distribution box and that appropriate connections are made to the Wall Connector.
Off	Off	3 flashes	No	Input miswired: possibly Line and Neutral are swapped.	The wiring between the wall power and the Wall Connector has been incorrectly installed. Consult your electrician.
Off	Off	4 flashes	After 1 minute and up to 4 times	Over or under voltage protection.	Consult your electrician to ensure appropriate voltage on the circuit breaker that services the Wall Connector.



Green Lights	Yellow Light	Red Light	Auto-Retry	What it Means	What to Do
Off	Off	5 flashes	After 1 minute retry (no limit on retries)	Over current protection.	Reduce the vehicle's charge current setting. If the problem persists and the attached vehicle is manufactured by Tesla, contact Tesla. If the problem persists and If the attached vehicle is not manufactured by Tesla, contact the original manufacturer.
Off	Off	6 flashes	After 1 minute retry (no limit on retries)	A communication error occurred between the Wall Connector and the vehicle.	Try again by disconnecting the Wall Connector from the vehicle and reconnecting. If possible, plug the vehicle into another Wall Connector or a Mobile Connector to determine if the vehicle is able to communicate with other charging equipment. If the problem persists, contact Tesla.
Top light on	Off	1 flash	No	Over temperature protection (latch-off)	Make sure the Wall Connector, vehicle connectors, and wall plug (if used) are not covered by anything and there is no heat source nearby. If the problem persists in normal ambient temperatures (under 100°F or 38°C), contact Tesla.
Top light on	Off	2 flashes	No	Non-Tesla vehicle attempting connection to non-compatible input distribution.	Compatible input distributions are: single-phase distribution or 400V, three-phase distribution.
Top light on	Off	3 flashes	No	Incorrect rotary switch setting.	Consult your electrician.



Green Lights	Yellow Light	Red Light	Auto-Retry	What it Means	What to Do
Top light on	Off	4 flashes	Not Applicable	Circuit Breaker Sharing Network: More than one Wall Connector is set to Leader.	Only one Wall Connector can be set to a leader configuration. All other linked Wall Connectors must be set to follower (position F). Set one of the Wall Connectors to Follower.
Top light on	Off	5 flashes	Not Applicable	Circuit Breaker Sharing Network: More than three Wall Connectors are set to Follower.	Move one or more Wall Connectors to a different circuit and disconnect it from this Circuit Breaker Sharing Network.
Top light on	Off	6 flashes	Not Applicable	Circuit Breaker Sharing Network: The networked Wall Connectors have different maximum current capabilities.	Contact Tesla.
Off	Off	Solid red	No	Wall Connector hardware failure. Possible failures include the following: <ul style="list-style-type: none"> • Contactor failed • Self test failed in CCID circuitry • Other possible hardware failures might be MCU, 3V3output, or the thermal sensor. 	Contact Tesla.

Reset

If a fault causes a RED error light to illuminate or flash and the fault condition is corrected, you use RESET the Wall Connector to resume normal operation. There are two ways to REST the Wall Connector:



- Press the RESET button for two to three seconds until the top lights changes from RED to GREEN. This clears the fault message but does not reboot the Wall Connector.
- In a rare situation, you might need to force the Wall Connector to reboot without recycling the input power. Hold the RESET button for five seconds. When the top light changes from RED to GREEN, release the RESET button. The top light should continue to illuminate GREEN. If the light returns to flashing RED, the fault state has not been corrected.



Questions?

- United States and Canada:
 - charginginstallation@tesla.com
 - +1-650-681-6133



1. Turn OFF power.
 -  **Warning:** RISK OF ELECTRIC SHOCK! Before continuing, use a voltmeter to ensure the power is off by confirming that NO VOLTAGE is present at the service wiring or terminals.
2. Use a non-conductive object to adjust the DIP switches to the appropriate grid setting and circuit breaker sharing setting (refer to Set the Operating Current on page 21).
3. Use a small flathead screwdriver to set the rotary switch to position "0" to put the Wall Connector into Test Mode.
 -  **Warning:** Power MUST remain OFF before setting or changing the DIP or rotary switches. Changing these switches with the power ON will not be recognized by the system and is dangerous due to the risk of electric shock.
4. Reattach the ribbon cable to the sealing cover.
5. Use a T20 security pin Torx driver to lightly secure the sealing cover by installing only the top screw.
6. Turn ON the circuit breaker.
7. Watch for any Red LEDs to be ON after a sequence of LED display; if so, there is a fault in the installation.
8. Listen for the click of a contactor or relay closing and opening.
9. Watch for Green streaming LEDs (for 5 seconds).

LEDs will revert to top Green LED ON and Red LEDs flashing (3 times).

Note: To review the pattern of blinking lights, press and hold the Reset button for 5 seconds.
10. Turn OFF the circuit breaker.
11. Remove the sealing cover screw, sealing cover. Disconnect the ribbon cable.
 -  **Caution:** Do not allow the sealing cover to hang from the ribbon cable. Doing so can damage the ribbon cable or its connectors.
12. Reposition the rotary switch to the appropriate setting (refer to Set the Operating Current on page 21).
13. Reattach the ribbon cable to the sealing cover.
14. Replace all the screws and reinstall the outer cover (refer to Secure the Cover and Power Up on page 22).



The Wall Connector includes an automatic load management feature whereby Wall Connector to Wall Connector communication allows you to split the maximum available load over a maximum of 4 Wall Connectors. The wire used for this local network must:

- Share the main power cable conduit or be housed in a separate conduit. In other words, the high voltage wires must be branched to a junction box from each individual unit.
- Be at least 18 AWG, 2 conductor, shielded, twisted-pair wire.

Warning: When load sharing, high voltage (L1, L2, Neutral, Earth) cabling must be spliced in a separate NEMA rated enclosure.

Note: Take additional precautions into consideration to prevent water ingress at the Wall Connectors when installing them outdoors.

Note: Consult with an electrician to ensure that the installation meets local regulations.

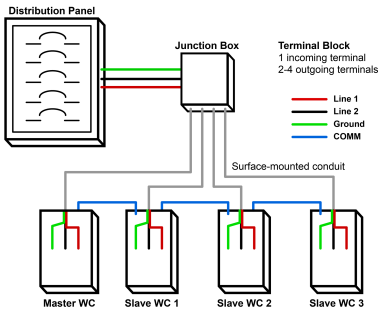

Daisy Chaining Multiple Wall Connectors

Each Wall Connector has one terminal block dedicated for the communication wiring as shown below. The left hand side of the terminal block is the input terminal and the right hand side the output terminal.

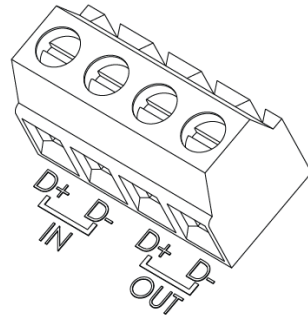

1. Form a daisy-chained network by connecting the cables from OUT to IN and always from positive to positive and negative to negative between each of the participating Wall Connectors (refer to Example of the Communication Wiring on page 31).
 - The signal wires between each Wall Connector should run in signal conduit. Use a 1/2" (13 mm) UL approved conduit hub to seal the signal conduit opening.
 - If the signal wire is routed in the power conduit with the power wires, the insulation rating of the signal wire should be equal to or greater than that of the power wires.
 - The maximum distance between Wall Connectors is 49 ft (15 m).
2. Set one Wall Connector as the leader by setting the Rotary Switch Position from 1 through D, depending on the maximum available output current. Set up to 3 Wall Connectors as followers by setting the Rotary Switch Positions to F. In the load sharing network, only one unit can be designated



as the leader (refer to Set the Operating Current on page 21).

- Confirm that the load sharing network is properly installed by observing the LED indicators in the Wall Connector. When starting up the circuit breaker for the first time, green lights turning ON for 5 seconds indicate a proper installation. The final display is:

Green Lights	Yellow Light	Red Light	What it Means...
On (top and bottom)	Off	Off	Leader unit
On (bottom)	Off	Off	Follower unit

Example of the Communication Wiring

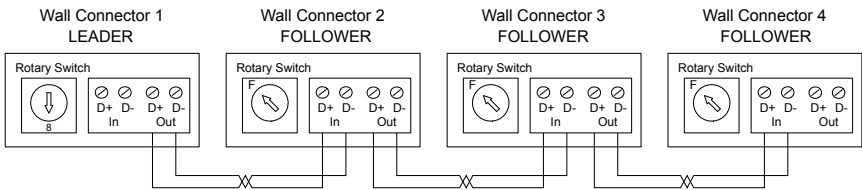

Other Load Sharing Behaviors

- Available current is redistributed equally among all connected vehicles whenever a new vehicle is plugged or unplugged from the network.
- During steady-state operation, the load sharing network toggles available current to each vehicle in 2A increments, every minute, to assess vehicle need. When a battery approaches full charge, the power consumption will taper until charging is complete. If the leader unit detects that a vehicle is no longer using all of its available current, it will reduce the current allocated to that vehicle.
- A follower Wall Connector will not charge if communication is lost with the leader Wall Connector.
- In rare cases, firmware updates on a leader Wall Connector will interrupt charging on the follower Wall Connector(s). This is normal behavior, and charging should resume once the firmware update is complete (15 minutes).



B

- bottom or rear entry
 - configurations, dimensions and spacing 11
 - example of the service wiring 19
 - installing the low profile bracket for 16

C

- cardboard template, using the 16
- cautions 3
- check the box contents 13
- circuit breaker
 - corresponding rotary switch settings 21
 - requirements 9
- circuit ratings, optional 6
- communications regulations 2
- conduit, about 11
- connect the wiring 19
- copyrights 2
- cover
 - removing the outer 18
 - removing the sealing 18
 - securing the outer 22

D

- dimensions 5
- DIP switches, configuring 21
- documentation errors, sending feedback 2

F

- features
 - circuit ratings, optional 6
 - load sharing 6
 - recovery from power outages 6
 - self-monitoring and recovery 6

I

- installation
 - for rear or bottom entry wiring 16
 - for top entry wiring 17
 - information, about 2
 - planning your 7
 - preparing for 18
 - tools and materials required 15
 - torque recommendations 19
- installation overview 15
- installation, testing 29

L

- lights, diagnostic 6
- lights, LED 24
- load sharing
 - about 6
 - configuring the DIP and rotary switches 21
 - example of the communication wiring 31
- low profile bracket
 - installing the 16

M

- minimum requirements 7

N

- notes 4

P

- planning your installation
 - circuit breaker requirements 9
 - location of the wall connectors 10
 - minimum requirements 7
 - service wiring 7
 - types of installations 11
- power outages, recovery from 6
- power ratings 5
- power up 22
- product specifications 2

R

- removing the outer cover 18
- reset button 6, 27, 29
- rotary switches, configuring 21

S

- safety instructions 3, 4
- securing the outer cover 22
- self-monitoring and recovery 6
- service wiring 7, 19
- set the operating current 21
- specifications
 - dimensions 5
 - power ratings 5
 - temperature limits 5



T

- temperature limits 5
- terminal blocks
 - connecting the service wiring to the 19
 - torque recommendations 19
- Tesla, contacting 28
- testing for proper operation 29
- top entry
 - bracket, installing the 17
 - configurations, dimension and spacing 11
 - example of the service wiring 19
 - wiring, installing the top entry bracket for 17
- trademarks 2
- troubleshooting 24, 27, 28, 30

W

- wall connectors
 - checking the box contents 13
 - connecting the terminal blocks 30
 - daisy chaining 30
 - example of the communication wiring 31
 - location of 10
 - optional configuration 30
 - power up 22
 - reset 27, 29
 - troubleshooting 30
- warnings 3
- wiring for load sharing 30

TESLA

P/N: 1069742-00-D

MNL, USER GUIDE, NA, 1PH 80A HW, WC GEN2



(P) PN:1069742-00-D

(T) TLN:TT80AMP1NA